



**finder**<sup>®</sup>  
SWITCH TO THE FUTURE

**38**  
SERIES

# Relay interface modules 0.1 - 2 - 3 - 5 - 6 - 8 - 16 A



Bottling plant



Packaging machines



Control panels



Traffic light controls



Vending machines



Programmable controllers





Panels for electrical distribution

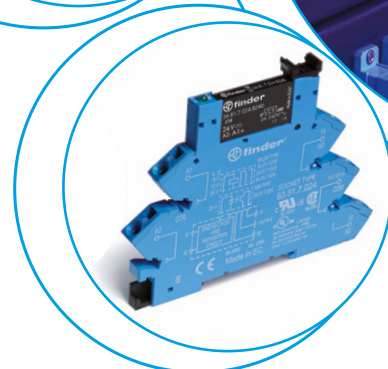
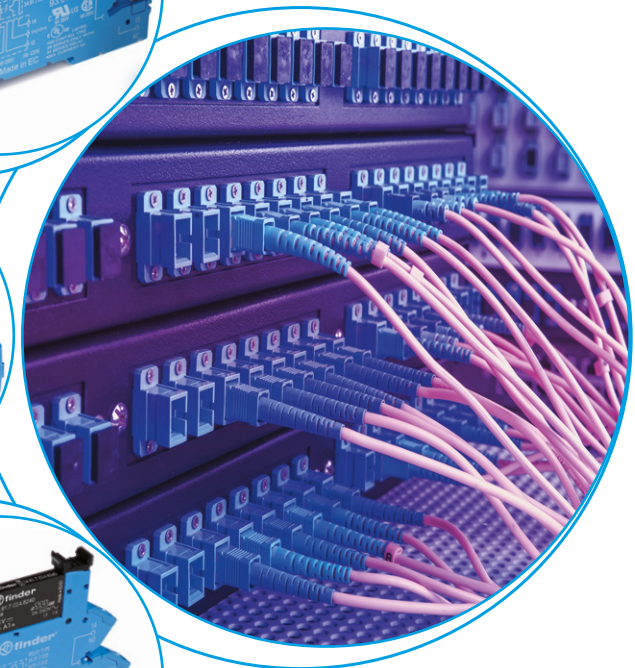
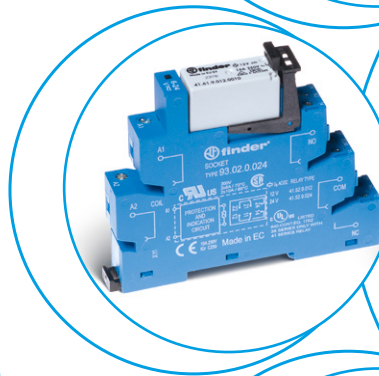
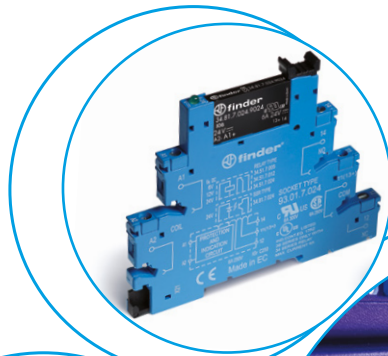

Labelling machines



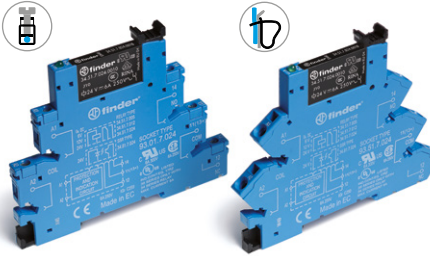
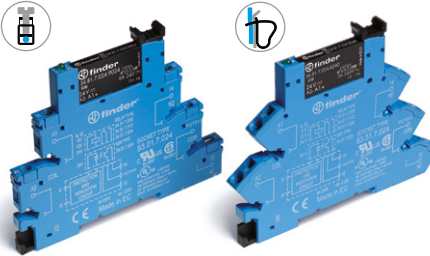
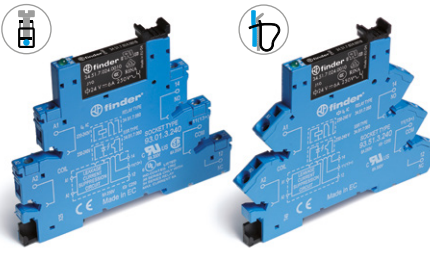
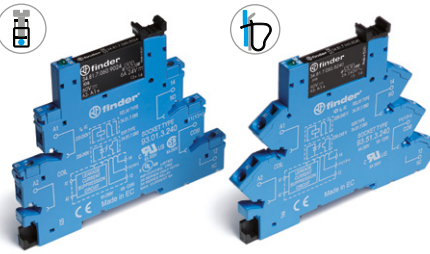

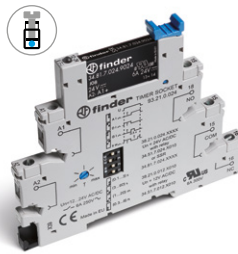
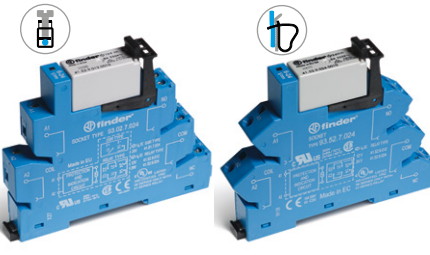
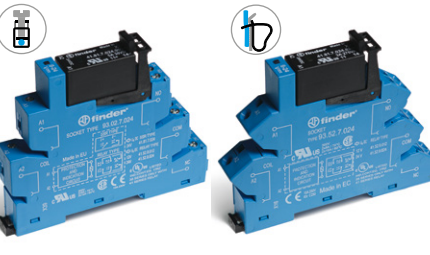
<p><b>Common features</b></p> <ul style="list-style-type: none"> <li>• Instant ejection of relay by plastic retaining clip</li> <li>• Integral coil indication and protection circuit</li> <li>• 35 mm rail (EN 60715) mounting</li> </ul>	<p><b>EMR</b> <b>Electromechanical Relays</b></p>	<p><b>SSR</b> <b>Solid State Relays</b></p>
<p><b>6.2 mm wide</b></p> <ul style="list-style-type: none"> <li>• EMR - DC, AC or AC/DC coil versions</li> <li>• SSR - DC or AC/DC input versions</li> <li>• Screw and Screwless terminal options</li> </ul>	<p><b>38.51/38.61</b></p>  <ul style="list-style-type: none"> <li>• 1 CO - 6 A/250 V AC</li> </ul> <p>Page 1</p>	<p><b>38.81/38.91</b></p>  <ul style="list-style-type: none"> <li>• Single solid state output: Options 0.1 A/48 V DC, 6 A/24 V DC, 2 A/240 V AC</li> <li>• Silent, high speed switching</li> <li>• Long electrical life</li> </ul> <p>Page 2</p>
<p><b>6.2 mm wide</b></p> <ul style="list-style-type: none"> <li>• Special coil/input leakage current suppression types</li> <li>• EMR - AC or AC/DC coil versions</li> <li>• SSR - AC or AC/DC input versions</li> <li>• Screw and Screwless terminal options</li> </ul>	<p><b>38.51.3... - 38.61.3...</b></p>  <ul style="list-style-type: none"> <li>• 1 CO - 6 A/250 V AC</li> </ul> <p>Page 1</p>	<p><b>38.81.3... - 38.91.3...</b></p>  <ul style="list-style-type: none"> <li>• Single solid state output: Options 0.1 A/48 V DC, 6 A/24 V DC, 2 A/240 V AC</li> <li>• Silent, high speed switching</li> <li>• Long electrical life</li> </ul> <p>Page 2</p>
<p><b>6.2 mm wide</b></p> <ul style="list-style-type: none"> <li>• Timed Interface module</li> <li>• 4 functions &amp; 4 time scales 0.1 s...6 h</li> <li>• EMR - AC/DC (12 or 24 V) supply versions</li> <li>• SSR - AC/DC (24 V) supply</li> <li>• Screw terminals</li> </ul>	<p><b>38.21</b></p>  <ul style="list-style-type: none"> <li>• 1 CO - 6 A/250 V AC</li> </ul> <p>Page 3</p>	<p><b>38.21...9024-8240</b></p>  <ul style="list-style-type: none"> <li>• Single solid state output: Options 6 A/24 V DC, 2 A/240 V AC</li> <li>• Silent, high speed switching</li> <li>• Long electrical life</li> </ul> <p>Page 3</p>
<p><b>14 mm wide</b></p> <ul style="list-style-type: none"> <li>• 2 pole 8 A or 1 pole 16 A</li> <li>• EMR - DC or AC/DC coil versions</li> <li>• SSR - DC input versions</li> <li>• Screw and Screwless terminal options</li> </ul>	<p><b>38.01/38.52/38.11/38.62</b></p>  <ul style="list-style-type: none"> <li>• 1 CO - 16 A/250 V AC</li> <li>• 2 CO - 8 A/250 V AC</li> </ul> <p>Page 4</p>	<p><b>38.31/38.41</b></p>  <ul style="list-style-type: none"> <li>• Single solid state output: Options 5 A/24 V DC, 3 A/240 V AC</li> <li>• Silent, high speed switching</li> <li>• Long electrical life</li> </ul> <p>Page 5</p>

**B**



**1 Pole - 6 A electromechanical relay interface modules, 6.2 mm wide.**

**Ideal interface for PLC and electronic systems**

- Sensitive DC coil or AC/DC coil versions
- Integral coil indication and protection circuit
- Instant ejection of relay using plastic retaining clip
- UL Listing (certain relay/socket combinations)
- 35 mm rail (EN 60715) mounting

38.51/38.51.3  
Screw terminal

38.61/38.61.3  
Screwless terminal



\* Special version for max ambient temperature +70 °C.

\*\* Maximum ambient temperature limitations apply in the case of adjacent mounting of modules, where the coil is energised with a duty cycle of  $\geq 50\%$  or where the ON time exceeds 1 hour:  
+55 °C: applies to groups limited to 2 adjacent modules and where each group is separated by an air gap  $\geq 6.2$  mm.  
+30 °C: applies to a group of more than 2 adjacent modules.

For outline drawing see page 13

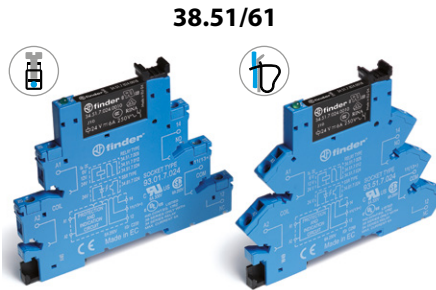

- 1 pole electromechanical relay
- Screw terminal and screwless terminal
- 35 mm rail (EN 60715) mounting

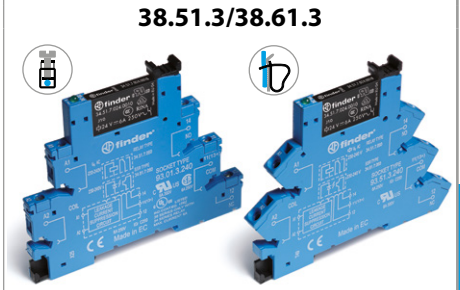
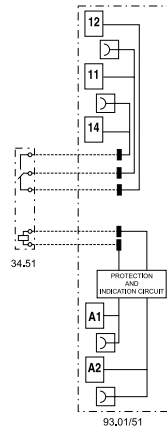

- Leakage current suppression
- 1 pole electromechanical relay
- Screw terminal and screwless terminal
- 35 mm rail (EN 60715) mounting

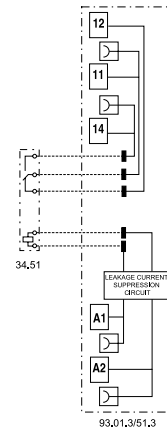

**Contact specification**

Contact configuration		1 CO (SPDT)	1 CO (SPDT)
Rated current/ Maximum peak current	A	6/10	6/10
Rated voltage/ Maximum switching voltage	V AC	250/400	250/400
Rated load AC1	VA	1500	1500
Rated load AC15 (230 V AC)	VA	300	300
Single phase motor rating (230 V AC)	kW	0.185	0.185
Breaking capacity DC1: 30/110/220 V	A	6/0.2/0.12	6/0.2/0.12
Minimum switching load	mW (V/mA)	500 (12/10)	500 (12/10)
Standard contact material		AgNi	AgNi

**Coil specification**

Nominal voltage ( $U_N$ )	V AC/DC	12 - 24 - 48 - 60 - (110...125) - (220...240)**	(110...125)	—
	V AC	(230...240)*	—	(230...240)
	V DC	6 - 12 - 24 - 48 - 60 (non polarized)	—	—
Rated power AC/DC	VA (50 Hz)/W	See page 9	1/1	0.5/—
Operating range	AC/DC	(0.8...1.1) $U_N$	(94...138)V	—
	AC	(184...264)V	—	(184...264)V
	DC	(0.8...1.2) $U_N$	—	—
Holding voltage	AC/DC	0.6 $U_N$ / 0.6 $U_N$	0.6 $U_N$ / 0.6 $U_N$	
Must drop-out voltage	AC/DC	0.1 $U_N$ / 0.05 $U_N$	44 V	72 V

**Technical data**

Mechanical life AC/DC	cycles	10 · 10 <sup>6</sup>	10 · 10 <sup>6</sup>
Electrical life at rated load AC1	cycles	60 · 10 <sup>3</sup>	60 · 10 <sup>3</sup>
Operate/release time	ms	5/6	5/6
Insulation between coil and contacts (1.2/50 $\mu$ s)	kV	6 (8 mm)	6 (8 mm)
Dielectric strength between open contacts	V AC	1000	1000
Ambient temperature range ( $U_N \leq 60$ V / > 60 V)	°C	-40...+70 / -40...+55	- / -40...+55
Protection category		IP 20	IP 20

**Approvals relay** (according to type)



**Single output - solid state relay interface modules, 6.2 mm wide.**

**Ideal interface for PLC and electronic systems**

- DC, AC or AC/DC input versions
- Supplied with integral coil indication and protection circuit
- Silent, high switching speed and long electrical life
- Instant ejection of relay using plastic retaining clip
- UL Listing (certain relay/socket combinations)
- 35 mm rail (EN 60715) mounting

38.81/38.81.3  
Screw terminal

38.91/38.91.3  
Screwless terminal



**38.81/38.91**

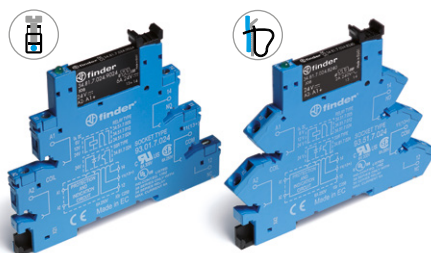

- AC or DC output switching
- SSR relay - DC input voltage
- Screw terminal and screwless terminal
- 35 mm rail (EN 60715) mounting

**38.81.3/38.91.3**

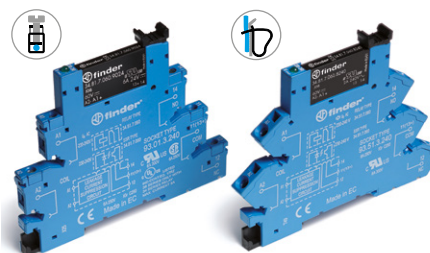

- Leakage current suppression
- AC or DC output
- SSR relay - AC or AC/DC input voltage
- Screw terminal and screwless terminal
- 35 mm rail (EN 60715) mounting

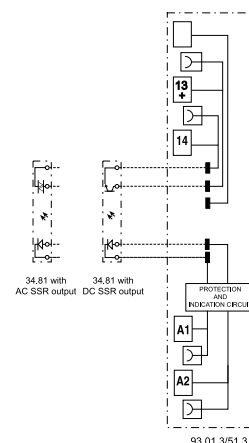
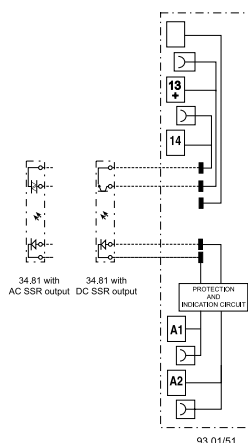

For outline drawing see page 13

**Output specification**

		1 NO (SPST-NO)			1 NO (SPST-NO)		
Contact configuration							
Rated current/ Maximum peak current (10 ms)	A	6/50	0.1/0.5	2/80	6/50	0.1/0.5	2/80
Rated voltage/ Maximum blocking voltage	V	24/33 DC	48/53 DC	240/— AC	24/33 DC	48/53 DC	240/— AC
Switching voltage range	V	(1.5...33)DC	(1.5...53)DC	(12...275)AC	(1.5...33)DC	(1.5...53)DC	(12...275)AC
Repetitive peak off-state voltage	V <sub>pk</sub>	—	—	800	—	—	800
Minimum switching current	mA	1	0.05	35	1	0.05	35
Max. "OFF-state" leakage current	mA	0.001	0.001	1.5	0.001	0.001	1.5
Max. "ON-state" voltage drop	V	0.4	1	1.6	0.4	1	1.6

**Input specification**

Nominal voltage (U <sub>N</sub> )	V AC	—			230...240		
	V DC	6 - 24 - 60			—		
	V AC/DC	(110...125) - (220...240)			110...125		
Operating range	V DC	See page 10			See page 10		
Control current	mA	See page 10			See page 10		
Release voltage	V DC	See page 10			See page 10		

**Technical data**

Operate/release time: ON/OFF (DC input)	ms	0.2/0.6	0.04/0.11	12/12	0.2/0.6	0.04/0.11	12/12
Dielectric strength between input/output	V AC	2500			2500		
Ambient temperature range	°C	-20...+55			-20...+55		
Environmental protection		IP20			IP20		

**Approvals relay** (according to type)



**Slim timed interface module, 6.2 mm wide.**

**1 pole, 6 A - electromechanical relay**  
**1 output, 2 A DC or AC - solid state relay**

- Electromechanical or solid state output
- Multi-functions timer
- AC/DC supply
- 4 time scales from 0.1 s to 6 h
- Instant ejection of relay using plastic retaining clip
- 6.2 mm wide, 35 mm rail (EN 60715) mounting

38.21  
Screw terminal



For outline drawing see page 13

**Contact specification**

Contact configuration		1 CO (SPDT)	
Rated current/ Maximum peak current	A	6/10	—
Rated voltage/ Maximum switching voltage	V AC	250/400	—
Rated load AC1	VA	1500	—
Breaking capacity DC1: 30/110/220 V	A	6/0.2/0.12	—
Minimum switching load	mW (V/mA)	500 (12/10)	—
Standard contact material		AgNi	—

**Output specification**

Output configuration		—	<b>DC output (...9024)</b>	<b>AC output (...8240)</b>
Rated current/Maximum peak current	A	—	1 NO (SPST-NO)	1 NO (SPST-NO)
Rated voltage/ Maximum blocking voltage	V	—	6/50	2/80
Switching voltage range	V	—	(24/33)DC	(240/—)AC
Repetitive peak off-state voltage	V <sub>pk</sub>	—	(1.5...33)DC	(12...275)AC
Minimum switching current	mA	—	—	800
Max. "OFF-state" leakage current	mA	—	1	35
Max. "ON-state" voltage drop	V	—	0.001	1.5
			0.4	1.6

**Supply specification**

Nominal voltage (U <sub>N</sub> )	V AC (50/60 Hz)/DC	12 - 24	24
Rated power	VA/W	0.5	0.5
Operating range	AC	(0.8...1.1)U <sub>N</sub>	(0.8...1.1)U <sub>N</sub>
	DC	(0.8...1.1)U <sub>N</sub>	(0.8...1.1)U <sub>N</sub>

**Technical data**

Specified time range		(0.1...3)s, (3...60)s, (1...20)min, (0.3...6)h	
Repeatability	%	± 1	
Recovery time	ms	≤ 50	
Setting accuracy-full range	%	5%	
Ambient temperature	°C	-40...+70	-20...+55

Protection category

IP 20

**Approvals relay** (according to type)



**38.21**

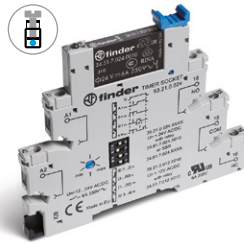

- 1 pole electromechanical output relay
- 12 or 24 V AC/DC supply
- Screw terminal
- 35 mm rail (EN 60715) mounting

**AI:** On-delay  
**DI:** Interval  
**GI:** Pulse delayed  
**SW:** Symmetrical flasher (starting pulse on)

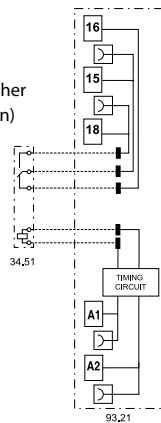

**38.21...9024-8240**

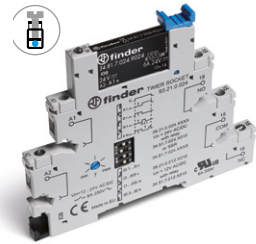

- DC or AC solid state output relays
- 24 V AC/DC supply voltage
- Screw terminal
- 35 mm rail (EN 60715) mounting

**AI:** On-delay  
**DI:** Interval  
**GI:** Pulse delayed  
**SW:** Symmetrical flasher (starting pulse on)

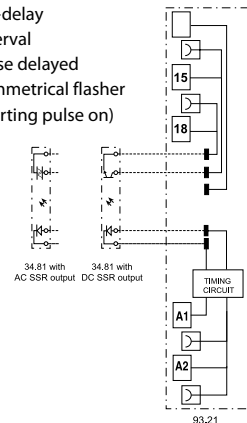

**Electromechanical relay interface modules,  
14 mm wide.**
**38.01 and 38.11 - 1 Pole 16 A**  
**38.52 and 38.62 - 2 Pole 8 A**
**Ideal interface for PLC and electronic systems**

- Sensitive DC coil or AC/DC coil versions
- Integral coil indication and protection circuit
- Instant ejection of relay using plastic retaining clip
- UL Listing (certain relay/socket combinations)
- 35 mm rail (EN 60715) mounting

B

 38.01/52  
Screw terminal

 38.11/62  
Screwless terminal

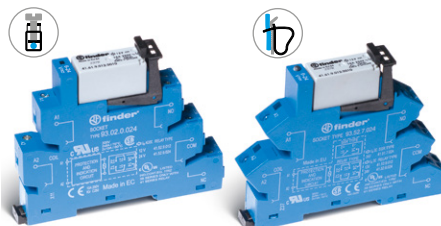
**38.01/38.11**

- Screw terminal and screwless terminal
- 1 pole electromechanical relay
- 35 mm rail (EN 60715) mounting

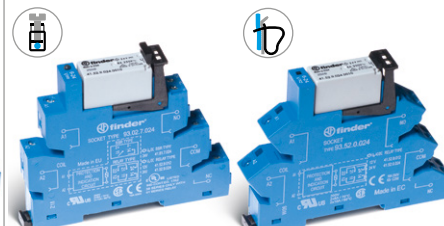
**38.52/38.62**

- Screw terminal and screwless terminal
- 2 pole electromechanical relay
- 35 mm rail (EN 60715) mounting

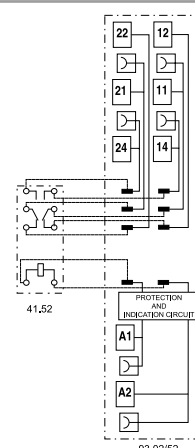
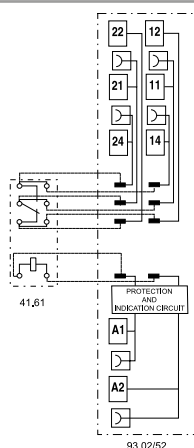

\* For currents > 10 A, contact terminals must be connected in parallel (21 with 11, 24 with 14, 22 with 12).

For outline drawing see page 13

**Contact specification**

Contact configuration		1 CO (SPDT)	2 CO (DPDT)
Rated current/Maximum peak current	A	16*/30	8/15
Rated voltage/ Maximum switching voltage	V AC	250/400	250/400
Rated load AC1	VA	4000	2000
Rated load AC15 (230 V AC)	VA	750	400
Single phase motor rating (230 V AC)	kW	0.5	0.3
Breaking capacity DC1: 30/110/220 V	A	16/0.3/0.12	8/0.3/0.12
Minimum switching load	mW (V/mA)	300 (5/5)	300 (5/5)
Standard contact material		AgNi	AgNi

**Coil specification**

Nominal voltage (U <sub>N</sub> )	V AC/DC	24 - 60 - (110...125) - (220...240)	24 - 60 - (110...125) - (220...240)
	V AC	230...240	230...240
	V DC	12 - 24 - 60	12 - 24 - 60
Rated power AC/DC	VA (50 Hz)/W	See page 9	See page 9
Operating range	AC/DC	0.8...1.1	0.8...1.1
	DC	(0.8...1.2)U <sub>N</sub>	(0.8...1.2)U <sub>N</sub>
Holding voltage	AC/DC	0.6 U <sub>N</sub> / 0.6 U <sub>N</sub>	0.6 U <sub>N</sub> / 0.6 U <sub>N</sub>
Must drop-out voltage	AC/DC	0.1 U <sub>N</sub> / 0.05 U <sub>N</sub>	0.1 U <sub>N</sub> / 0.05 U <sub>N</sub>

**Technical data**

Mechanical life AC/DC	cycles	10 · 10 <sup>6</sup>	10 · 10 <sup>6</sup>
Electrical life at rated load AC1	cycles	50 · 10 <sup>3</sup>	60 · 10 <sup>3</sup>
Operate/release time	ms	8/10	8/10
Insulation between coil and contacts (1.2/50 μs)	kV	6 (8 mm)	6 (8 mm)
Dielectric strength between open contacts	V AC	1000	1000
Ambient temperature range (U <sub>N</sub> ≤ 60 V / > 60 V)	°C	-40...+70 / -40...+55	-40...+70 / -40...+55
Protection category		IP 20	IP 20

**Approvals relay** (according to type)



**Single output - solid state relay interface modules, 14 mm wide.**

**Ideal interface for PLC and electronic systems**

- DC input versions
- Supplied with integral coil indication and protection circuit
- Silent, high switching speed and long electrical life
- Instant ejection of relay using plastic retaining clip
- UL Listing (certain relay/socket combinations)
- 35 mm rail (EN 60715) mounting

38.31  
Screw terminal



38.41  
Screwless terminal



**38.31/38.41**

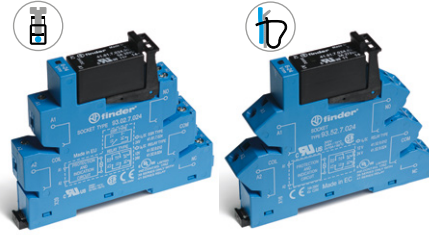

- Screw terminal and screwless terminal
- AC or DC output switching
- SSR relay - DC input voltage
- 35 mm rail (EN 60715) mounting

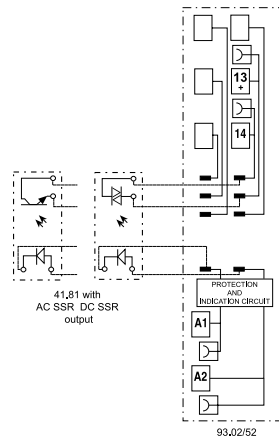

For outline drawing see page 13

**Output specification**

Contact configuration	1 NO (SPST-NO)	1 NO (SPST-NO)
Rated current/ Maximum peak current (10 ms)	A	5/40
Rated voltage/ Maximum blocking voltage	V	(24/35)DC
Switching voltage range	V	(1.5...24)DC
Repetitive peak off-state voltage	V <sub>pk</sub>	600
Minimum switching current	mA	1
Max. "OFF-state" leakage current	mA	0.01
Max. "ON-state" voltage drop	V	0.3

**Input specification**

Nominal voltage (U <sub>N</sub> )	V AC/DC	24
	V DC	12 - 24
Operating range	V DC	See page 10
Control current	mA	See page 10
Release voltage	V DC	See page 10

**Technical data**

Operate/release time: ON/OFF (DC input)	ms	0.05/0.25	12/12
Dielectric strength between input/output	V AC	2500	
Ambient temperature range	°C	-20...+55	
Environmental protection		IP20	

**Approvals relay** (according to type)



**B**

## Ordering information

### Electromechanical relay - 1 or 2 Pole

Example: 38 series screw terminal relay interface module, 1 CO (SPDT), sensitive 12 V DC coil.

3 8 . 5 1 . 7 . 0 1 2 . 0 0 5 0

B

**Series**

**Type**

- 0 = Electromechanical 16 A relay, with screw terminal
- 1 = Electromechanical 16 A relay, with screwless terminal
- 2 = Timer multifunction (AI, DI, GI, SW), with screw terminal
- 5 = Electromechanical relay, with screw terminal
- 6 = Electromechanical relay, with screwless terminal

**No. of poles**

- 1 = 1 pole, 6 or 16 A
- 2 = 2 pole, 8 A

**Coil version**

- 0 = AC (50/60 Hz)/DC
- 3 = Leakage current suppression for (110...125)V AC/DC - (230...240)V AC
- 7 = Sensitive DC, (6, 12, 24, 48, 60)V only
- 8 = AC (50/60 Hz)

**Coil voltage**

See coil specifications

**D: Special versions**

0 = Standard

**C: Options**

- 5 = Standard DC
- 6 = Standard AC or AC/DC

**B: Contact circuit**

0 = CO (nPDT)

**A: Contact material**

- 0 = AgNi Standard
- 4 = AgSnO<sub>2</sub>
- 5 = AgNi + Au

**Selecting features and options: only combinations in the same row are possible.**

Type	Coil version	A	B	C	D
38.01/11	7	0 - 4	0	5	0
38.01/11	0 - 8	0 - 4	0	6	0
38.51/61	7	0 - 4 - 5	0	5	0
38.51/61	0 - 3 - 8	0 - 4 - 5	0	6	0
38.52/62	7	0 - 5	0	5	0
38.52/62	0 - 8	0 - 5	0	6	0
38.21	0	0	0	6	0

**Ordering information**

**Solid state relay - Single output - 6.2 & 14 mm wide**

Example: 38 series screw terminal SSR relay interface module, 6.2 mm wide, 6 A output, 24 V DC input.

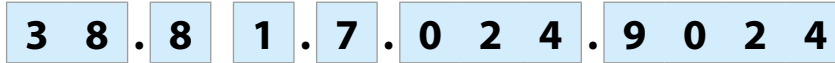

**Series**

**Type**

- 21 = Timer SSR 6.2 mm wide, with screw terminal
- 31 = SSR 14 mm wide, with screw terminal
- 41 = SSR 14 mm wide, with screwless terminal
- 81 = SSR 6.2 mm wide, with screw terminal
- 91 = SSR 6.2 mm wide, with screwless terminal

**Input version**

- 0 = AC/DC
- 3 = Leakage current suppression for (110...125)V AC/DC and (230...240)V AC SSR only
- 7 = DC, (6, 24, 60)V SSR only

**Input voltage**

See input specifications

**Output version**

- 9024 = 6 A - 24 V DC (38.21, 38.81 & 38.91)
- 9024 = 5 A - 24 V DC (38.31 & 38.41)
- 7048 = 0.1 A - 48 V DC (38.81 & 38.91)
- 8240 = 2 A - 240 V AC (38.21, 38.81 & 38.91)
- 8240 = 3 A - 240 V AC (38.31 & 38.41)



**Selecting features and options: only combinations in the same row are possible.**

Type	Input version	Output version
38.81/91	7	9024 - 7048 - 8240
38.81/91	0 - 3	9024 - 7048 - 8240
38.31/41	0 - 7	9024 - 8240
38.21	0	9024 - 8240

## Technical data - 1 & 2 Pole Electromechanical Relays

### Insulation

Insulation according to EN 61810-1	insulation rated voltage	V	250	400
	rated impulse withstand voltage	kV	4	4
	pollution degree		3	2
	overvoltage category		III	III
Insulation between coil and contacts (1.2/50 μs)		kV	6 (8 mm)	
Dielectric strength between open contacts		V AC	1000	

### Insulation between coil terminals

Rated impulse voltage (surge) differential mode (according to EN 61000-4-5)	kV (1.2/50 μs)	2
-----------------------------------------------------------------------------	----------------	---

### Other data

		1 Pole 6 A	1 Pole 16 A - 2 Pole 8 A
Bounce time: NO/NC	ms	1/6	2/5
Vibration resistance (10...55)Hz: NO/NC	g	10/5	15/2
Power lost to the environment	without contact current	W	0.2 (12 V) - 0.9 (240 V)
	with rated current	W	0.5 (12 V) - 1.5 (240 V)

### Terminals

Wire strip length	mm	10	10		
⊖ Screw torque	Nm	0.5	—		
Max. wire size		solid cable	stranded cable	solid cable	stranded cable
	mm <sup>2</sup>	1 x 2.5 / 2 x 1.5	1 x 2.5 / 2 x 1.5	1 x 2.5	1 x 2.5
	AWG	1 x 14 / 2 x 16	1 x 14 / 2 x 16	1 x 14	1 x 14
		<b>38.01 / 38.52</b>		<b>38.11 / 38.62</b>	
Wire strip length	mm	10	10		
⊖ Screw torque	Nm	0.5	—		
Max. wire size		solid cable	stranded cable	solid cable	stranded cable
	mm <sup>2</sup>	1 x 2.5 / 2 x 1.5	1 x 2.5 / 2 x 1.5	1 x 2.5	1 x 2.5
	AWG	1 x 14 / 2 x 16	1 x 14 / 2 x 16	1 x 14	1 x 14

## Contact specification - 1 & 2 Pole Electromagnetic Relays

F 38 - Electrical life (AC) v contact current, 1 Pole 6 A

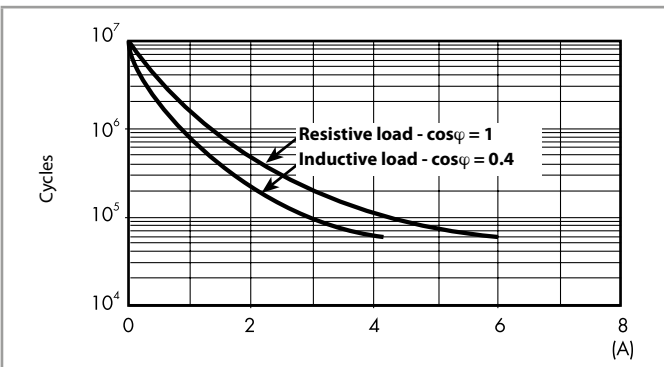

F 38 - Electrical life (AC) v contact current, 1 Pole 16 A and 2 Pole 8 A

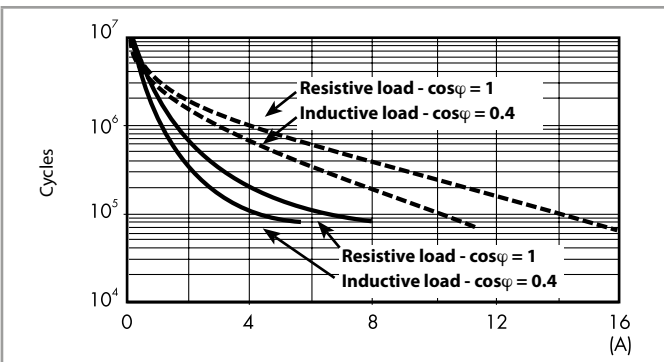

————— : 2 Pole 8 A  
————— : 1 Pole 16 A

H 38 - Maximum DC1 breaking capacity, 1 Pole 6 A

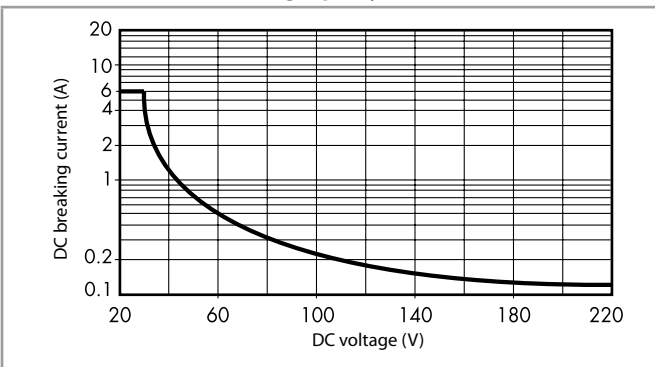

H 38 - Maximum DC1 breaking capacity, 1 Pole 16 A and 2 Pole 8 A

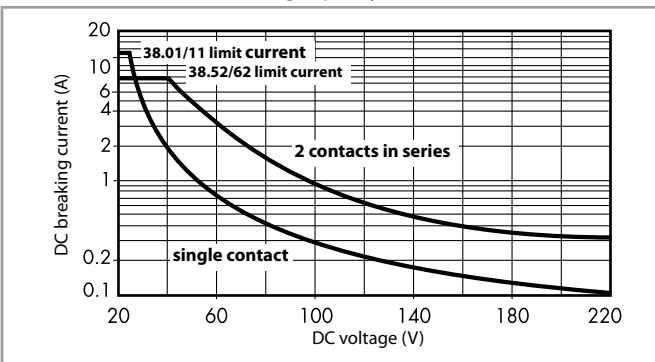

- When switching a resistive load (DC1) having voltage and current values under the curve, an electrical life of  $\geq 60 \cdot 10^3$  (1 Pole) or  $\geq 80 \cdot 10^3$  (2 Pole) can be expected.
- In the case of DC13 loads, the connection of a diode in parallel with the load will permit a similar electrical life as for a DC1 load. Note: the release time for the load will be increased.

### Coil specifications - 1 Pole 6 A Electromechanical Relay

**Coil data sensitive DC, 1 Pole**

Nominal voltage $U_N$	Coil code	Operating range		Rated coil consumption I at $U_N$	Power consumption P at $U_N$
		$U_{min}$	$U_{max}$		
V		V	V	mA	W
6	7.006	4.8	7.2	35	0.2
12	7.012	9.6	14.4	15.2	0.2
24	7.024	19.2	28.8	10.4	0.3
48	7.048	38.4	57.6	6.3	0.3
60	7.060	48	72	7	0.4

**Coil data AC/DC, 1 Pole**

Nominal voltage $U_N$	Coil code	Operating range		Rated coil consumption I at $U_N$	Power consumption P at $U_N$
		$U_{min}$	$U_{max}$		
V		V	V	mA	VA/W
12	0.012	9.6	13.2	16	0.2/0.2
24	0.024	19.2	26.4	12	0.3/0.2
48	0.048	38.4	52.8	6.9	0.3/0.3
60	0.060	48	66	7	0.5/0.5
110...125	0.125	88	138	5(*)	0.6/0.6(*)
220...240	0.240	176	264	4(*)	1/0.9(*)

(\*) Rated coil consumption and power consumption values relate to  $U_N = 125$  and 240 V.

**Coil data AC, 1 Pole (indicated for max ambient temperature +70 °C)**

Nominal voltage $U_N$	Coil code	Operating range		Rated coil consumption I at $U_N$	Power consumption P at $U_N$
		$U_{min}$	$U_{max}$		
V		V	V	mA	VA/W
(230...240) AC	8.240	184	264	3	0.7/0.3

**Coil data, leakage current suppression types, 1 Pole**

Nominal voltage $U_N$	Coil code	Operating range		Rated coil consumption I at $U_N$	Power consumption P at $U_N$
		$U_{min}$	$U_{max}$		
V		V	V	mA	VA/W
(110...125) AC/DC	3.125	94	138	8(*)	1/1(*)
(230...240) AC	3.240	184	264	7(*)	1.7/0.5(*)

(\*) Rated coil consumption and power consumption values relate to  $U_N = 125$  and 240 V.

The 38 Series interface modules (supply version 3) have built-in leakage current suppression to address industry concerns of the contacts not dropping-out when there is residual current in the circuit; at (110...125)V AC and (230...240)V AC.

This problem can occur, for example, when connecting the interface modules to PLCs with triac outputs or when connecting via relatively long cables.

### Coil specifications - 1 Pole 16 A and 2 Pole 8 A Electromechanical Relay

**Coil data sensitive DC, 1 Pole 16 A and 2 Pole 8 A**

Nominal voltage $U_N$	Coil code	Operating range		Rated coil consumption I at $U_N$	Power consumption P at $U_N$
		$U_{min}$	$U_{max}$		
V		V	V	mA	W
12	7.012	9.6	14.4	41	0.5
24	7.024	19.2	28.8	19.5	0.5
60	7.060	48	72	8	0.5

**Coil data AC/DC, 1 Pole 16 A and 2 Pole 8 A**

Nominal voltage $U_N$	Coil code	Operating range		Rated coil consumption I at $U_N$	Power consumption P at $U_N$
		$U_{min}$	$U_{max}$		
V		V	V	mA	W
24	0.024	19.2	26.4	20	0.5/0.5
60	0.060	48	66	7.1	0.5/0.5
110...125	0.125	88	138	4.6	0.6/0.6
220...240	0.240	184	264	3.8	0.9/0.9

**Coil data AC, 1 Pole 16 A and 2 Pole 8 A**

Nominal voltage $U_N$	Coil code	Operating range		Rated coil consumption I at $U_N$	Power consumption P at $U_N$
		$U_{min}$	$U_{max}$		
V		V	V	mA	VA/W
230...240	8.230	184	264	5.3	1.2/0.6

### Coil specification - 1 & 2 Pole Electromagnetic Relays

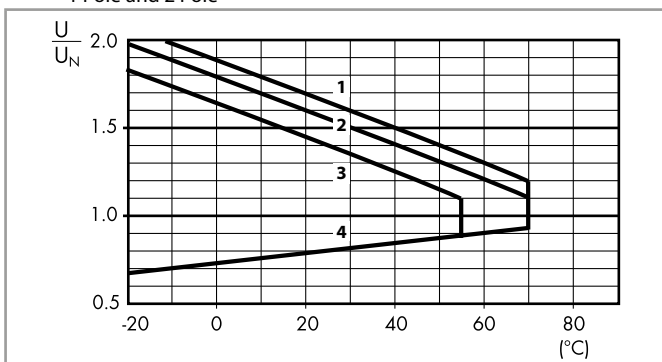

**R 38 - DC coil operating range v ambient temperature**

1 Pole and 2 Pole



- 1 - Max. permitted coil voltage at nominal load (DC coil).
- 2 - Max. permitted coil voltage at nominal load (AC/DC coils  $U \leq 60V$ ).
- 3 - Max. permitted coil voltage at nominal load (AC/DC coils  $U > 60V$ ).
- 4 - Min pick-up voltage with coil at ambient temperature.

## Technical data - Solid State Relays

Other data			38.81/38.91		38.31/38.41	
Power lost to the environment	without output current	W	0.25 (24 V DC)		0.5	
	with rated current	W	0.4		2.2 (DC output)/3 (AC output)	
Terminals			38.81		38.91	
Wire strip length		mm	10		10	
 Screw torque		Nm	0.5		—	
Max. wire size			solid cable	stranded cable	solid cable	stranded cable
		mm <sup>2</sup>	1 x 2.5 / 2 x 1.5	1 x 2.5 / 2 x 1.5	1 x 2.5	1 x 2.5
		AWG	1 x 14 / 2 x 16	1 x 14 / 2 x 16	1 x 14	1 x 14
			<b>38.31</b>		<b>38.41</b>	
Wire strip length		mm	10		10	
 Screw torque		Nm	0.5		—	
Max. wire size			solid cable	stranded cable	solid cable	stranded cable
		mm <sup>2</sup>	1 x 2.5 / 2 x 1.5	1 x 2.5 / 2 x 1.5	1 x 2.5	1 x 2.5
		AWG	1 x 14 / 2 x 16	1 x 14 / 2 x 16	1 x 14	1 x 14
			<b>38.31</b>		<b>38.41</b>	

## Input specifications - Solid State Relays type 38.81 and 38.91 - 6.2 mm wide

### Input data DC

Nominal voltage $U_N$	Supply code	Operating range		Release voltage $U$	Rated coil consumption $I$ at $U_N$	Power consumption $P$
		$U_{min}$	$U_{max}$			
V		V	V	V	mA	W
6	7.006	5	7.2	2.4	7	0.2
24	7.024	16.8	30	10	10.5	0.3
60	7.060	35.6	72	20	6.5	0.4

### Input data - Leakage current suppression types

Nominal voltage $U_N$	Supply code	Operating range		Release voltage $U$	Rated coil consumption $I$ at $U_N$	Power consumption $P$ at $U_N$
		$U_{min}$	$U_{max}$			
V		V	V	V	mA	W
110...125 AC/DC	3.125	94	138	44	8(*)	1/1(*)
230...240 AC	3.240	184	264	72	6.5(*)	1.6/0.6(*)

(\*) Rated coil consumption and power consumption values relate to  $U_N = 125$  and  $240$  V.

### Input data AC/DC

Nominal voltage $U_N$	Supply code	Operating range		Release voltage $U$	Rated coil consumption $I$ at $U_N$	Power consumption $P$
		$U_{min}$	$U_{max}$			
V		V	V	V	mA	VA/W
110...125	0.125	88	138	22	5.5*	0.7/0.7
220...240	0.240	184	264	44	3.5*	1/0.9

(\*) Rated coil consumption and power consumption values relate to  $U_N = 125$  and  $240$  V.

The 38 Series interface modules (supply version 3) have built-in leakage current suppression to address industry concerns of the contacts not dropping-out when there is residual current in the circuit; at (110...125)V AC and (230...240)V AC.

This problem can occur, for example, when connecting the interface modules to PLCs with triac outputs or when connecting via relatively long cables.

## Input specification - Solid State Relay types 38.31 and 38.41 - 14 mm wide

### Input data DC

Nominal voltage $U_N$	Supply code	Operating range		Release voltage $U$	Rated coil consumption $I$ at $U_N$	Power consumption $P$
		$U_{min}$	$U_{max}$			
V		V	V	V	mA	W
12	7.012	9.6	18	5	9	0.2
24	7.024	16.8	30	5	12	0.3

### Input data AC/DC

Nominal voltage $U_N$	Supply code	Operating range		Release voltage $U$	Rated coil consumption $I$ at $U_N$	Power consumption $P$
		$U_{min}$	$U_{max}$			
V		V	V	V	mA	W
24	0.024	16.8	30	9	16.5	0.3

**Output specification - Solid State Relays**

**L 34-1 - Output DC current v ambient temperature**

38.x1.x.xxx.9024 (only 38.81/91/21)

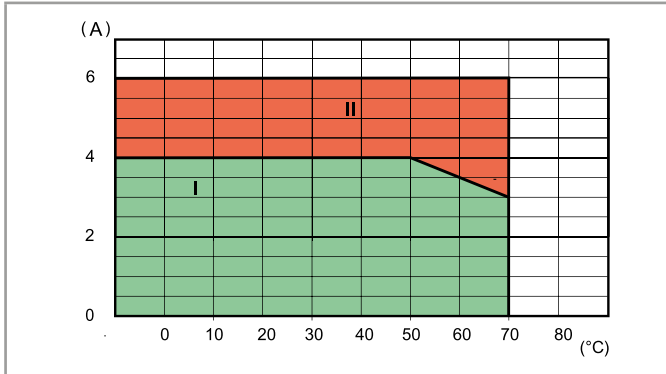

**L 34 - Output AC current v ambient temperature**

38.x1.x.xxx.8240 (only 38.81/91/21)

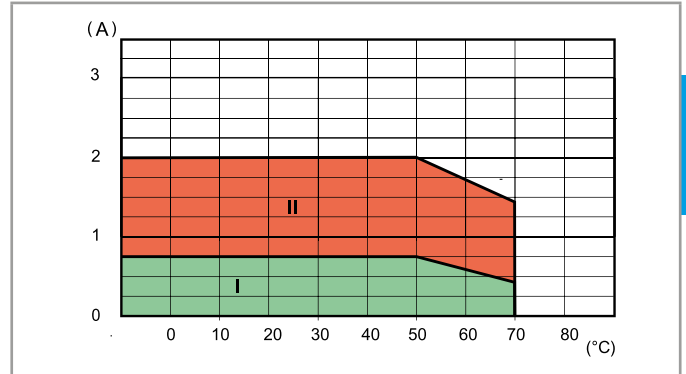

**I:** SSR installed as a group (without gap between sockets)

**II:** SSR installed individually in free air, or with a gap  $\geq 9$  mm, which implies a not significant influence from nearby components

**Max recommended switching frequency** (Cycles/Hour, with 50% Duty-cycle) at ambient temperature 50°C, single mounting (only 38.81/91/21)

Load	38.x1.x.xxx. <b>9024</b>	38.x1.x.xxx. <b>8240</b>	38.x1.x.xxx. <b>7048</b>
24 V 6 A DC1	180 000	—	—
24 V 3 A DC L/R = 10 ms	5000	—	—
24 V 2 A DC L/R = 40 ms	3600	—	—
24 V 1 A DC L/R = 40 ms	6500	—	—
24 V 0.8 A DC L/R = 40 ms	9000	—	—
24 V 1.5 A DC L/R = 80 ms	3250	—	—
230 V 2 A AC1	—	60 000	—
230 V 1.25 A AC15	—	3600	—
48 V 0.1 A DC1	—	—	60 000

### Additional technical data - Timed Interface Module

#### EMC specifications

Type of test		Reference standard	
Electrostatic discharge	contact discharge	EN 61000-4-2	4 kV
	air discharge	EN 61000-4-2	8 kV
Radio-frequency electromagnetic field (80 ÷ 1000 MHz)		EN 61000-4-3	10 V/m
Fast transients (burst) (5-50 ns, 5 kHz) on Supply terminals		EN 61000-4-4	4 kV
Surges (1.2/50 µs) on Supply terminals	common mode	EN 61000-4-5	4 kV
	differential mode	EN 61000-4-5	4 kV
Radio-frequency common mode (0.15 ÷ 80 MHz) on Supply terminals		EN 61000-4-6	10 V
Radiated and conducted emission		EN 55022	class B

#### Other data

		EMR	SSR
Power lost to the environment	without contact current	W 0.1	0.1
	with rated current	W 0.6	0.5

#### Terminals

		38.21	
Wire strip length	mm	10	
Screw torque	Nm	0.5	
Max. wire size		solid cable	stranded cable
	mm <sup>2</sup>	1 x 2.5 / 2 x 1.5	1 x 2.5 / 2 x 1.5
	AWG	1 x 14 / 2 x 16	1 x 14 / 2 x 16

### Times scales

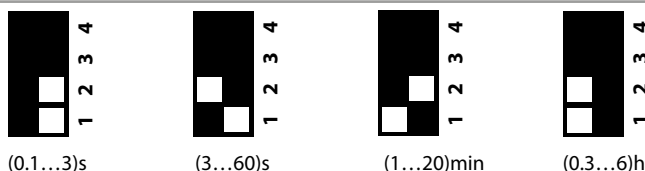

### Functions

LED	Supply voltage	NO contact/output
	OFF	Open
	ON	Open (time in progress)
	ON	Closed

### Wiring diagram

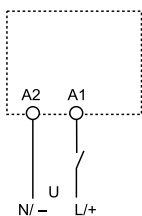

U = Supply voltage

= Output contact



#### (AI) On-delay.

Apply power to timer. Output contacts transfer after preset time has elapsed. Reset occurs when power is removed.

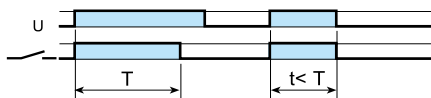
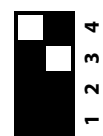

#### (DI) Interval.

Apply power to timer. Output contacts transfer immediately. After the preset time has elapsed, contacts reset.

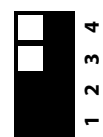

#### (GI) Pulse delayed.

Apply power to timer. Output contacts transfer after preset time has elapsed. Reset occurs after a fixed time of 0.5 s.

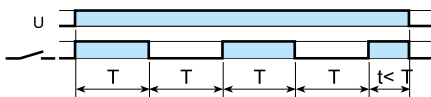
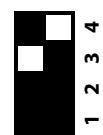

#### (SW) Symmetrical flasher (starting pulse on).

Apply power to timer. Output contacts transfer immediately and cycle between ON and OFF for as long as power is applied. The ratio is 1:1 (time on = time off).



**Outline drawings**

Types 38.21  
38.51 / 38.51.3  
38.81 / 38.81.3  
Screw terminal

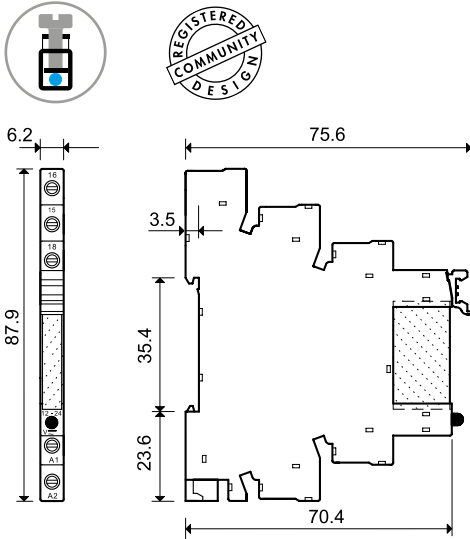

Types 38.01  
38.31  
38.52  
Screw terminal

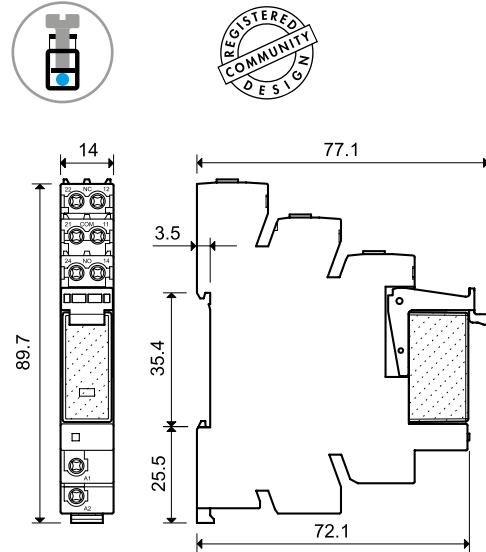

Types 38.61 / 38.61.3  
38.91 / 38.91.3  
Screwless terminal

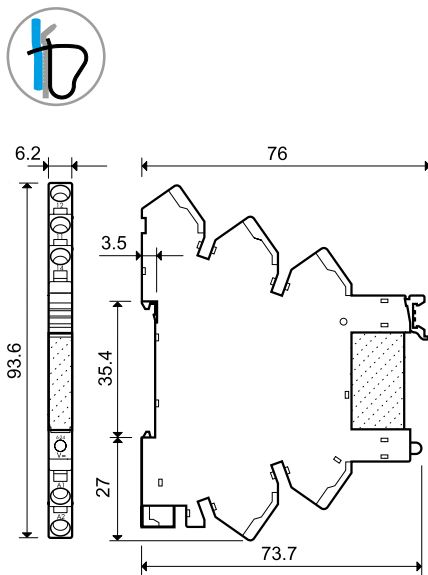

Types 38.11  
38.41  
38.62  
Screwless terminal

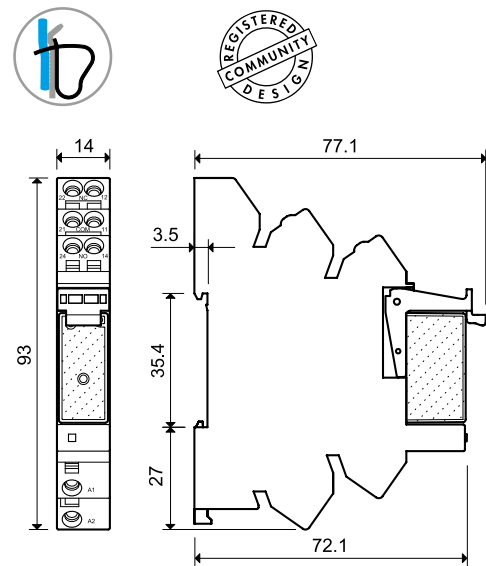

**B**

## Electromechanical Relay & Socket Combinations

### Screw terminal - 1 Pole relay 6 A

Interface Module Code	Coil voltage	Relay	Socket
38.51.0.012.0060	12 V AC/DC	34.51.7.012.0010	93.01.0.024
38.51.0.024.0060	24 V AC/DC	34.51.7.024.0010	93.01.0.024
38.51.0.048.0060	48 V AC/DC	34.51.7.048.0010	93.01.0.060
38.51.0.060.0060	60 V AC/DC	34.51.7.060.0010	93.01.0.060
38.51.0.125.0060	(110...125)V AC/DC	34.51.7.060.0010	93.01.0.125
38.51.0.240.0060	(220...240)V AC/DC	34.51.7.060.0010	93.01.0.240
38.51.3.125.0060	(110...125)V AC/DC	34.51.7.060.0010	93.01.3.125
38.51.3.240.0060	(230...240)V AC	34.51.7.060.0010	93.01.3.240
38.51.7.006.0050	6 V DC	34.51.7.005.0010	93.01.7.024
38.51.7.012.0050	12 V DC	34.51.7.012.0010	93.01.7.024
38.51.7.024.0050	24 V DC	34.51.7.024.0010	93.01.7.024
38.51.7.048.0050	48 V DC	34.51.7.048.0010	93.01.7.060
38.51.7.060.0050	60 V DC	34.51.7.060.0010	93.01.7.060
38.51.8.240.0060	(230...240)V AC	34.51.7.060.0010	93.01.8.240

### Screwless terminal - 1 Pole relay 6 A

Interface Module Code	Coil voltage	Relay	Socket
38.61.0.012.0060	12 V AC/DC	34.51.7.012.0010	93.51.0.024
38.61.0.024.0060	24 V AC/DC	34.51.7.024.0010	93.51.0.024
38.61.0.125.0060	(110...125)V AC/DC	34.51.7.060.0010	93.51.0.125
38.61.0.240.0060	(220...240)V AC/DC	34.51.7.060.0010	93.51.0.240
38.61.3.125.0060	(110...125)V AC/DC	34.51.7.060.0010	93.51.3.125
38.61.3.240.0060	(230...240)V AC	34.51.7.060.0010	93.51.3.240
38.61.7.012.0050	12 V DC	34.51.7.012.0010	93.51.7.024
38.61.7.024.0050	24 V DC	34.51.7.024.0010	93.51.7.024
38.61.8.240.0060	(230...240)V AC	34.51.7.060.0010	93.51.8.240

### Screw terminal - 1 Pole relay 16 A

Interface Module Code	Coil voltage	Relay	Socket
38.01.7.012.0050	12 V DC	41.61.9.012.0010	93.02.7.024
38.01.7.024.0050	24 V DC	41.61.9.024.0010	93.02.7.024
38.01.7.060.0050	60 V DC	41.61.9.060.0010	93.02.7.060
38.01.0.024.0060	24 V AC/DC	41.61.9.024.0010	93.02.0.024
38.01.0.060.0060	60 V AC/DC	41.61.9.060.0010	93.02.0.060
38.01.0.125.0060	125 V AC/DC	41.61.9.110.0010	93.02.0.125
38.01.0.240.0060	240 V AC/DC	41.61.9.110.0010	93.02.0.240
38.01.8.230.0060	230 V AC	41.61.9.110.0010	93.02.8.230

### Screwless terminal - 1 Pole relay 16 A

Interface Module Code	Coil voltage	Relay	Socket
38.11.7.012.0050	12 V DC	41.61.9.012.0010	93.52.7.024
38.11.7.024.0050	24 V DC	41.61.9.024.0010	93.52.7.024
38.11.7.060.0050	60 V DC	41.61.9.060.0010	93.52.7.060
38.11.0.024.0060	24 V AC/DC	41.61.9.024.0010	93.52.0.024
38.11.0.060.0060	60 V AC/DC	41.61.9.060.0010	93.52.0.060
38.11.0.125.0060	125 V AC/DC	41.61.9.110.0010	93.52.0.125
38.11.0.240.0060	240 V AC/DC	41.61.9.110.0010	93.52.0.240
38.11.8.230.0060	230 V AC	41.61.9.110.0010	93.52.8.230

### Screw terminal - 2 Pole relay 8 A

Interface Module Code	Coil voltage	Relay	Socket
38.52.0.024.0060	24 V AC/DC	41.52.9.024.0010	93.02.0.024
38.52.0.060.0060	60 V AC/DC	41.52.9.060.0010	93.02.0.060
38.52.0.125.0060	(110...125)V AC/DC	41.52.9.110.0010	93.02.0.125
38.52.0.240.0060	(220...240)V AC/DC	41.52.9.110.0010	93.02.0.240
38.52.7.012.0050	12 V DC	41.52.9.012.0010	93.02.7.024
38.52.7.024.0050	24 V DC	41.52.9.024.0010	93.02.7.024
38.52.7.060.0050	60 V DC	41.52.9.060.0010	93.02.7.060
38.52.8.230.0060	(230...240)V AC	41.52.9.110.0010	93.02.8.230

### Screwless terminal - 2 Pole relay 8 A

Interface Module Code	Coil voltage	Relay	Socket
38.62.0.024.0060	24 V AC/DC	41.52.9.024.0010	93.52.0.024
38.62.0.060.0060	60 V AC/DC	41.52.9.060.0010	93.52.0.060
38.62.0.125.0060	(110...125)V AC/DC	41.52.9.110.0010	93.52.0.125
38.62.0.240.0060	(220...240)V AC/DC	41.52.9.110.0010	93.52.0.240
38.62.7.012.0050	12 V DC	41.52.9.012.0010	93.52.7.024
38.62.7.024.0050	24 V DC	41.52.9.024.0010	93.52.7.024
38.62.7.060.0050	60 V DC	41.52.9.060.0010	93.52.7.060
38.62.8.230.0060	(230...240)V AC	41.52.9.110.0010	93.52.8.230

B

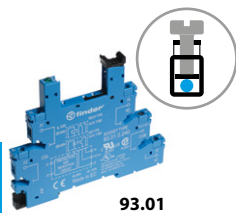

93.01

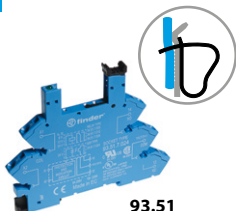

93.51

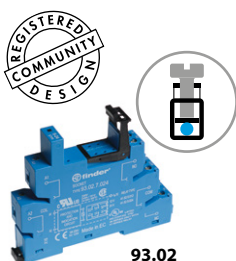

93.02

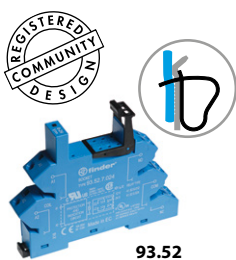

93.52

Approvals  
(according to type):



 Certain relay/socket combinations

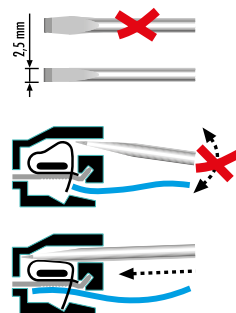

### Solid State Relay & Socket Combinations - 6.2 mm wide

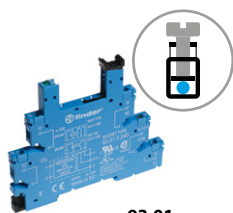

93.01

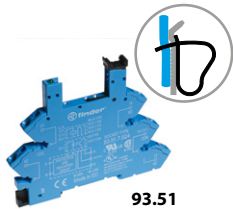

93.51

Approvals  
(according to type):



Certain relay/socket combinations

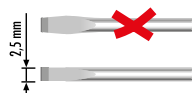

#### Screw terminal

Interface Module Code	Input voltage	Relay	Socket
38.81.7.006.xxxx	6 V DC	34.81.7.005.xxxx	93.01.7.024
38.81.7.024.xxxx	24 V DC	34.81.7.024.xxxx	93.01.7.024
38.81.7.060.xxxx	60 V DC	34.81.7.060.xxxx	93.01.7.060
38.81.0.125.xxxx	(110...125)V AC/DC	34.81.7.060.xxxx	93.01.0.125
38.81.0.240.xxxx	(220...240)V AC/DC	34.81.7.060.xxxx	93.01.0.240
38.81.3.125.xxxx	(110...125)V AC/DC	34.81.7.060.xxxx	93.01.3.125
38.81.3.240.xxxx	(230...240)V AC	34.81.7.060.xxxx	93.01.3.240

#### Screwless terminal

Interface Module Code	Input voltage	Relay	Socket
38.91.7.006.xxxx	6 V DC	34.81.7.005.xxxx	93.51.7.024
38.91.7.024.xxxx	24 V DC	34.81.7.024.xxxx	93.51.7.024
38.91.7.060.xxxx	60 V DC	34.81.7.060.xxxx	93.51.7.060
38.91.0.125.xxxx	(110...125)V AC/DC	34.81.7.060.xxxx	93.51.0.125
38.91.0.240.xxxx	(220...240)V AC/DC	34.81.7.060.xxxx	93.51.0.240
38.91.3.125.xxxx	(110...125)V AC/DC	34.81.7.060.xxxx	93.51.3.125
38.91.3.240.xxxx	(230...240)V AC	34.81.7.060.xxxx	93.51.3.240

Example: .xxxx  
.9024  
.7048  
.8240

### Solid State Relay & Socket Combinations - 14 mm wide

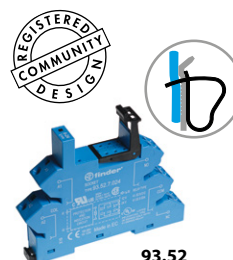

93.52

Approvals  
(according to type):



#### Screw terminal

Interface Module Code	Input voltage	Relay	Socket
38.31.0.024.xxxx	24 V AC/DC	41.81.7.024.xxxx	93.02.0.024
38.31.7.012.xxxx	12 V DC	41.81.7.012.xxxx	93.02.7.024
38.31.7.024.xxxx	24 V DC	41.81.7.024.xxxx	93.02.7.024

#### Screwless terminal

Interface Module Code	Input voltage	Relay	Socket
38.41.0.024.xxxx	24 V AC/DC	41.81.7.024.xxxx	93.52.0.024
38.41.7.012.xxxx	12 V DC	41.81.7.012.xxxx	93.52.7.024
38.41.7.024.xxxx	24 V DC	41.81.7.024.xxxx	93.52.7.024

### SSR / EMR & Timer Socket Combinations

#### Screw terminal

Interface Module Code	Input / Coil voltage	Relay	Socket
38.21.0.012.0060	12 V AC/DC	34.51.7.012.0010	93.21.0.024
38.21.0.024.0060	24 V AC/DC	34.51.7.024.0010	93.21.0.024
38.21.0.024.xxxx	24 V AC/DC	34.81.7.024.xxxx	93.21.0.024

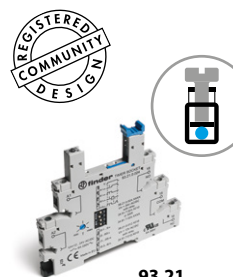

93.21

Approvals  
(according to type):



Accessories

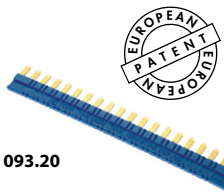

093.20

B

Approvals  
(according to type):



<b>20-way jumper link</b> for 38.21/51/61/81/91	093.20 (blue)	093.20.0 (black)	093.20.1 (red)
Rated values	36 A - 250 V		

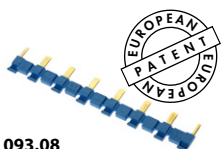
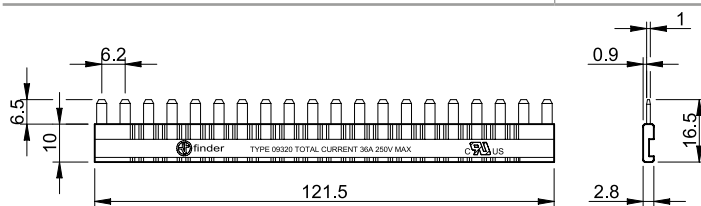

093.08

Approvals  
(according to type):



<b>8-way jumper link</b> for 38.01/11/31/41/52/62	093.08 (blue)	093.08.0 (black)	093.08.1 (red)
Rated values	10 A - 250 V		

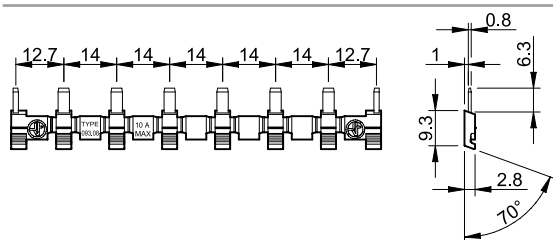

093.01

<b>Plastic separator</b>	093.01
--------------------------	--------

Thickness 2 mm, required at the start and the end of a group of interfaces.

Can be used for visual separation group, must be used for:

- protective separation of different voltages of neighbouring PLC interfaces according to VDE 0106-101
- protection of cut jumper links

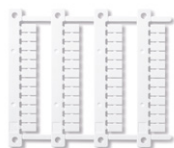

093.48

<b>Sheet of marker tags</b> for 38.21/51/61/81/91, plastic, 48 tags, 6 x 10 mm	093.48
--------------------------------------------------------------------------------	--------

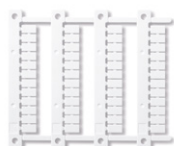

060.48

<b>Sheet of marker tags (CEMBRE Thermal transfer printers)</b> for 38.01/11/31/41/52/62 types (48 tags), 6 x 12 mm	060.48
--------------------------------------------------------------------------------------------------------------------	--------